

Digital Multimedia Projector

User's Manual

Thank you very much for purchasing this DLP™ Technology Projector.

Please read this operating guide to ensure correct use of the device. After reading this manual, keep it for future reference.

Outline

This DLP™ Technology Projector can display various computer signals and NTSC/PAL/SECAM video signals.

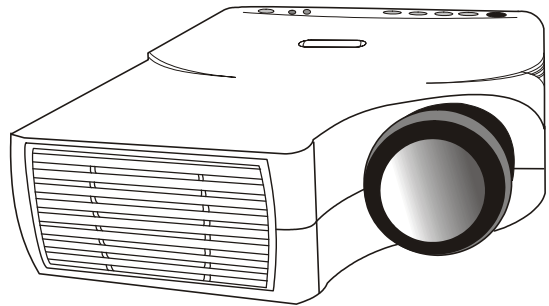

Features

- (1) High brightness
- (2) High resolution
- (3) Compact size, light weight for portability
- (4) RGB input terminal
- (5) RS232 Communication
- (6) Mouse emulation
- (7) Complies with VESA DDC1/2B specifications

Copyright

Copyright © 2002. All rights reserved. No part of this publication may be reproduced, transmitted, transcribed, stored in a retrieval system or translated into any language or computer language, in any form or by any means, electronic, mechanical, magnetic, optical, chemical, manual or otherwise, without the prior written permission of this company.

Disclaimer

This Corporation. makes no representations or warranties, either expressed or implied, with respect to the contents hereof and specifically disclaims any warranties, merchantability or fitness for any particular purpose. Further, this company reserves the right to revise this publication and to make changes from time to time in the contents hereof without obligation of this company to notify any person of such revision or changes.

Fill this in!!

For the convenience of service, record the following information in the space below. The serial number is on the back of the product.

Monitor Information

Product Name:

Serial Number:

Date of Purchase:

Dealer Information

Dealer:

Telephone

Number:

Address:

Caution

TO PREVENT SHOCK, DO NOT OPEN THE CABINET. NO USER –SERVICEABLE PARTS INSIDE. REFER SERVICING TO QUALIFIED PLUS SERVICE PERSONNEL. AND PLEASE READ ALL OF THESE INSTRUCTIONS BEFORE YOU OPERATE YOUR PROJECTOR. SAVE THESE INSTRUCTIONS FOR FUTURE REFERENCE .

Safety Instructions

1. Read all of these instructions before you operate your projector and save for future reference.
2. The lamp becomes extremely hot during operation. Allow the projector to cool for approximately 45 minutes prior to removing the lamp assembly for replacement. Do not operate lamps beyond the rated lamp life. Excessive operation of lamps beyond rated life could cause them to explode in rare occasions.
3. Power is still available when the projector is in the standby mode. Never replace lamp assembly or any electronic components unless the projector is unplugged.
4. Do not attempt to service this product yourself, as opening or removing covers may damage the components inside and will void your warranty.
5. Do not place this product on an unstable cart, stand, or table. The product may fall, causing serious damage to the product.
6. The Standard Remote Control contains a low-power laser that acts as a pointing device during presentations. The light beam may cause injury if pointed directly into a person's eyes.
7. This product is capable of displaying inverted images for ceiling mount configurations. Please use suitable equipment for mounting the unit and make sure it is securely installed.
8. Openings in front or at two sides are for ventilation. They must not be blocked or covered.
9. For ventilation reasons, the fan continues to operate for about 1 minute after the projector has been powered off. Please do not unplug the power cord until the fan stops.
10. Do not look straight at the projector lens during operation. The intense light beam may injure your eyes.

Table of Contents

Introduction	1
Projector Features	1
Description	2
A. FRONT	2
B. REAR	2
C. BOTTOM	2
Installation	3
A. Positioning	3
B. Adjustable Feet	3
Moving the Projector	4
Accessories	5
Connection	6
A. Connecting the Projector to Computer/Notebook	6
B. Connecting the Projector to Macintosh/Power Book	7
Operation	8
Turn On/Off Procedure	8
A. Power on	8
B. Standby	8
External Control	8
A. Control Pad	8
B. Remote Control	10
Usage and Replacement of Lamp	12
A. Lamp/temperature Status LED Indicator	12
B. Replacing the Lamp	13
OSD	15
Main OSD Menu	15
A. Display Page	16
B. Image Page	16
C. Control Page	17
D. Source Page	18
Other Correspondent Remote Functions and Messages	19
Maintenance and Troubleshooting	20
A. Lamp Replacement	20
B. Cleaning the Lens	20
C. Troubleshooting	20
Specifications	21
A. Optical	21
B. Electrical	21
C. Mechanical	21
D. Preset Display Resolution Table	21
Appendix	22
AV Connection Port	22
AV Control Pad	22
Connecting the Box	23

Introduction

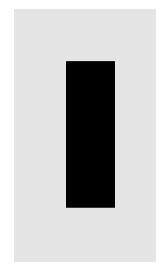

Projector Features

A. Image Resolution

Fully compatible with true SVGA/ XGA, and supports SXGA using advanced intelligent compression technology. The advanced intelligent compression technology enables it to present clear compression SVGA/XGA images without line omission.

B. Brightness

Provides superior brightness using TI's Digital Micromirror Device (DMD) and our own optical design, with a geometric effect that increases light usage efficiency. By increasing the light usage efficiency we can better reproduce the three basic colors (RGB) required for color reproduction on a single DMD.

C. Portability

This projector has a sophisticated shape, like that of an attaché case, with a retractable carrying handle that is extremely compact and lightweight. It helps you make powerful presentations wherever you go with its 5-pound weight and B5 size.

D. Keystone

The projection position is already set to the height of the line of vision; there is no keystone effect. Even when projecting above or under the height of the line of vision, image distortion (if any) can be adjusted using the hotkey "KEYSTONE" correction function.

E. Multilanguage

The OSD (On Screen Display: information screens and menus) in 7 languages (English, French, German, Italian, Spanish, Simplified Chinese and Traditional Chinese) provides you with additional information to help you make corrections with OSD operation in your native languages.

F. Auto Detect System

This projector can detect display signals from PCs with frequently used timing automatically or use hotkey "AUTO" to do the optimization simultaneously. It does not require complicated adjustments in order to project picture images from PCs.

G. Ceiling Mount and Rear Screen Projection

The projector is equipped with a full mirror scan conversion function (vertical/horizontal mirror), which allows the image to be reversed for ceiling mounting as well as for rear projection applications.

H. AV box

An AV box is optional, and users can attach one or two to the projector. Additionally, our AV box video standard is compatible with:

NTSC	U.S. and Canada standard
PAL	Western Europe standard

SECAM France and Eastern Europe standard

NTSC4.43 Middle East standard

If users want to watch CATV, AV box will serve the need.

Description

A. FRONT

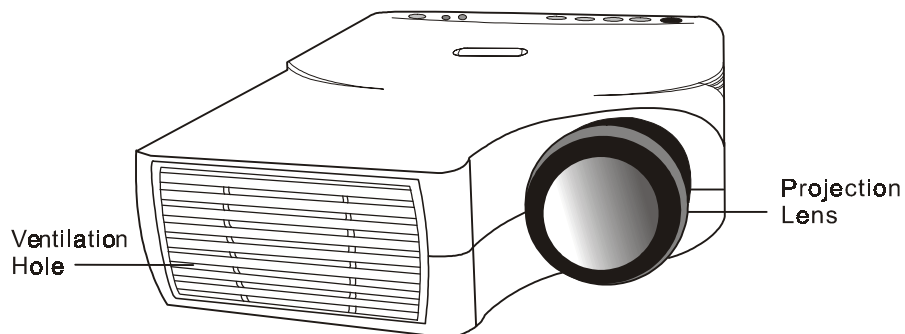

Figure 1 Front view

B. REAR

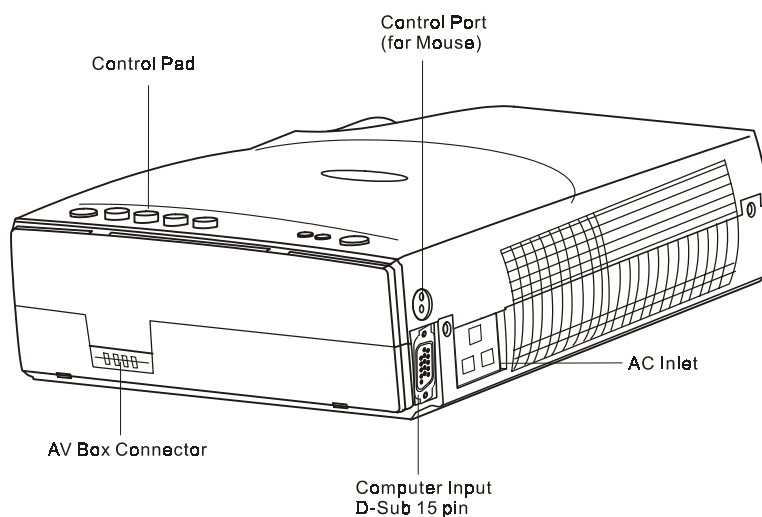

Figure 2 Rear view

C. BOTTOM

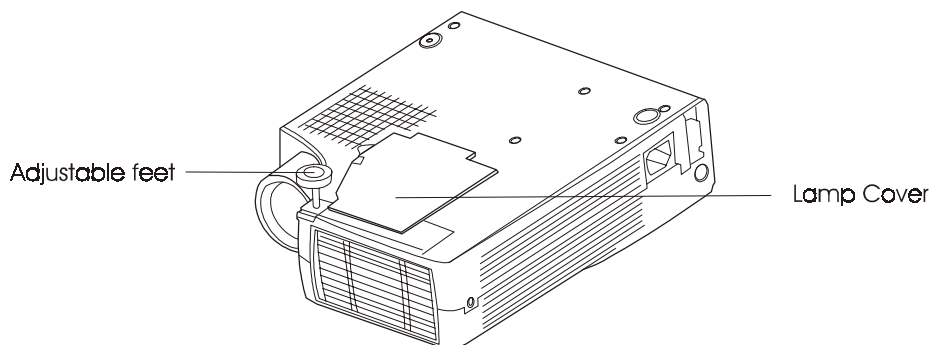
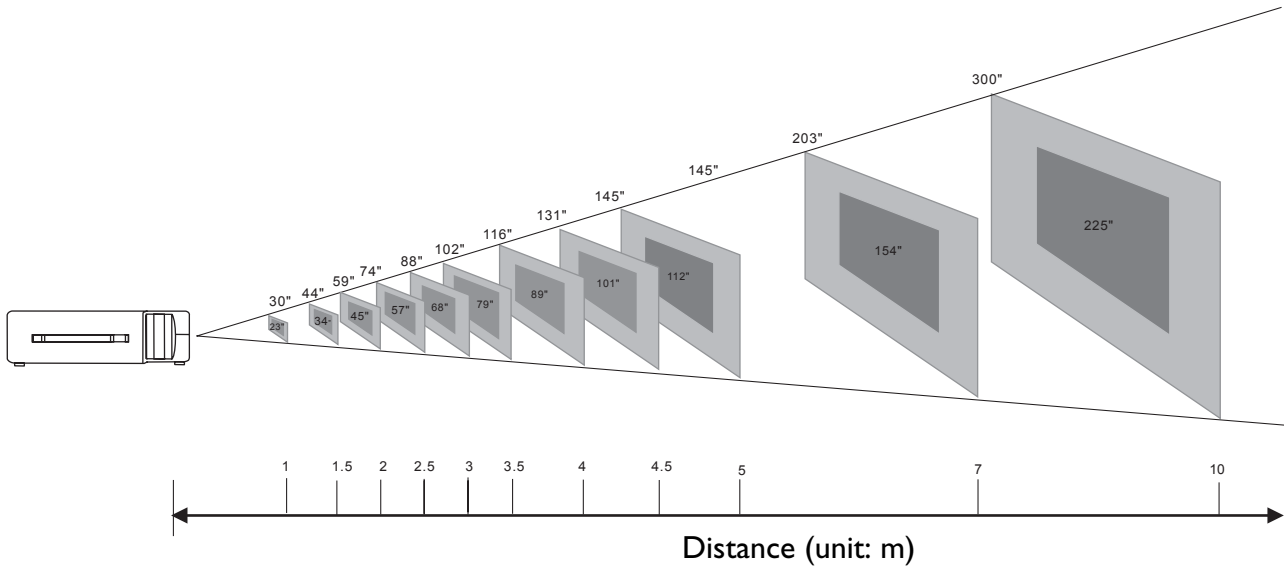

Figure 3 Bottom view

Installation

A. Positioning

This projector is basically designed to project on a flat projection surface. It can focus from 1m–10m and adjust the screen size like figure below.



Projection screen size (diagonal length)	Max. Zoom	30"	44"	59"	74"	88"	102"	116"	131"	145"	203"	300"
	Min. Zoom	23"	34"	45"	57"	68"	79"	89"	101"	112"	154"	225"
Distance (unit: m)		1	1.5	2	2.5	3.0	3.5	4	4.5	5	7	10

Figure 4 Positioning

B. Adjustable Feet

Picture tilt and projection angle can be adjusted by twisting Adjustable Feet. The projection angle can be adjusted 2° to 8.5° .

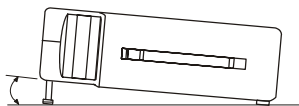

Figure 5 Adjustable feet

Moving the Projector

Use the carrying handle when moving the projector.

Replace the lens cover and rotate the feet fully clockwise (to shorten the feet) when moving the projector to prevent damage to the projector.

⚠ Caution

The carry bag (supplied) is intended to protect the projector from dust and scratches on the surface of the cabinet. It is not designed to protect the projector from external shock. Do not transport the projector in an unsuitable transport case by using a courier or transport service. This may cause damage to the projector.

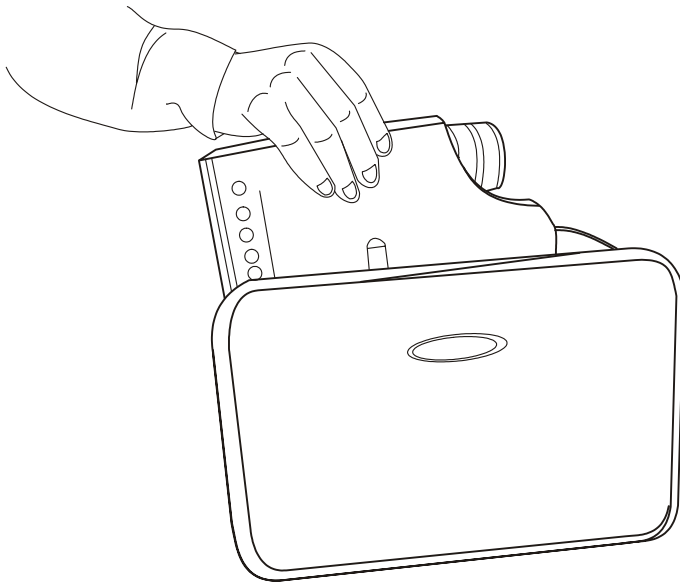

Figure 6 Moving the projector

Accessories

Please check and make sure your box contains everything listed below. If any pieces are missing, contact your dealer.

Please save the original box and packing materials in case you ever need to ship the unit.

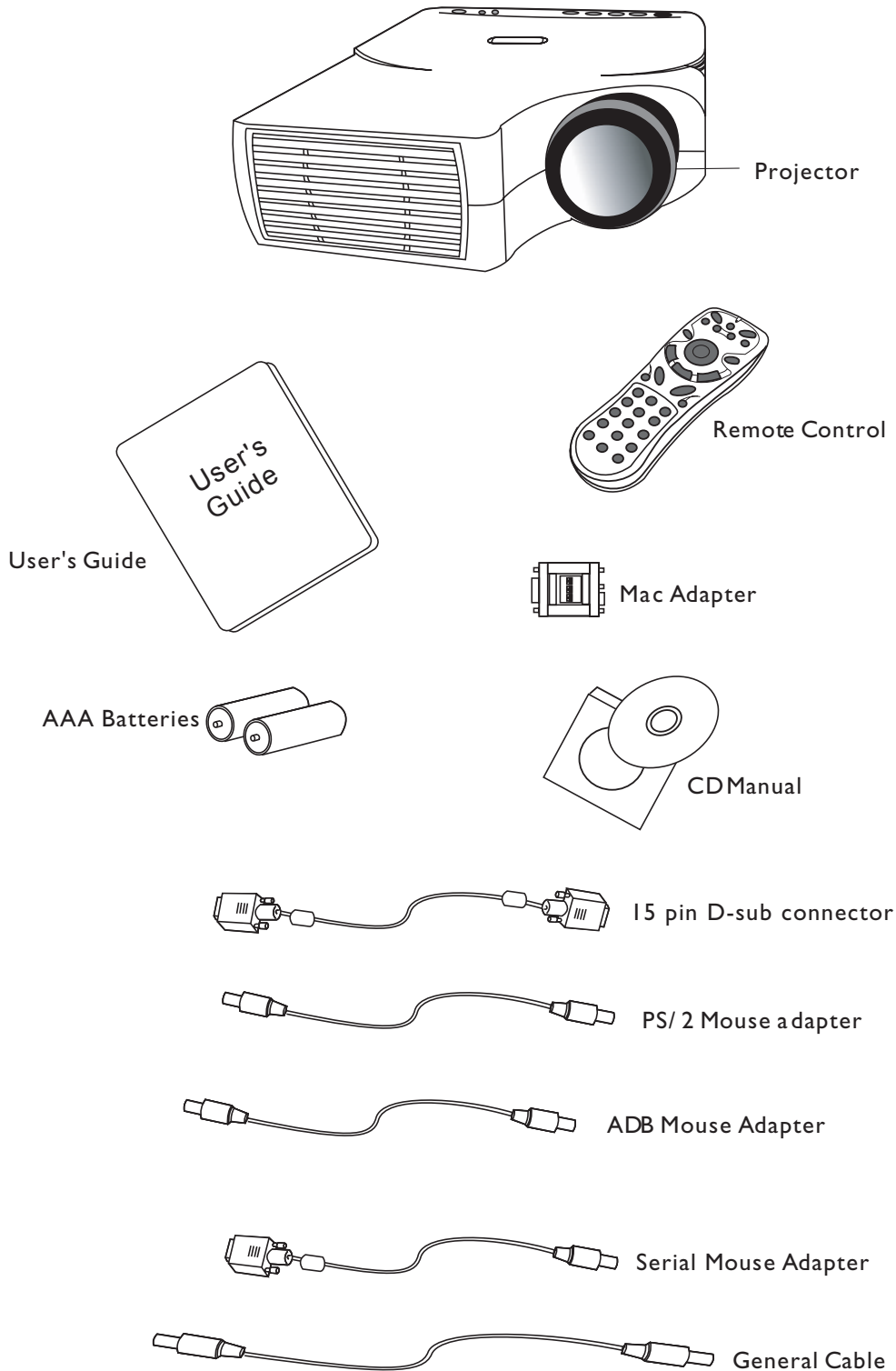

Figure 7 Accessories

Connection

2

A. Connecting the Projector to Computer/Notebook

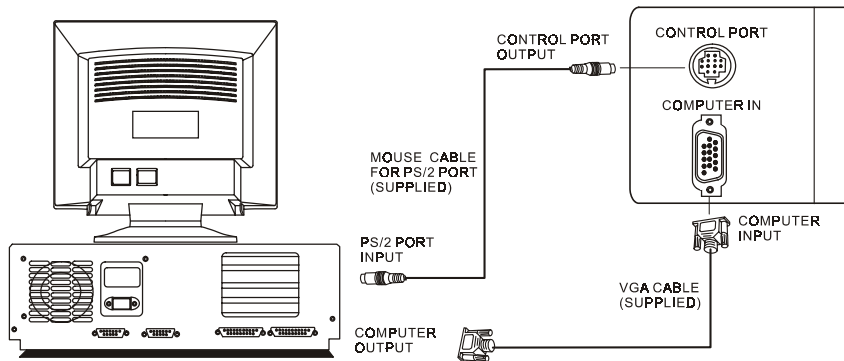

Figure 8 Connection to PC

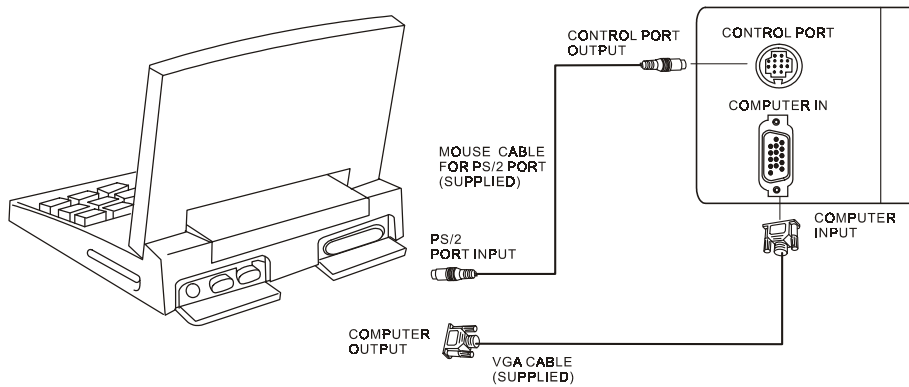

Figure 9 Connection to notebook

B. Connecting the Projector to Macintosh/Power Book

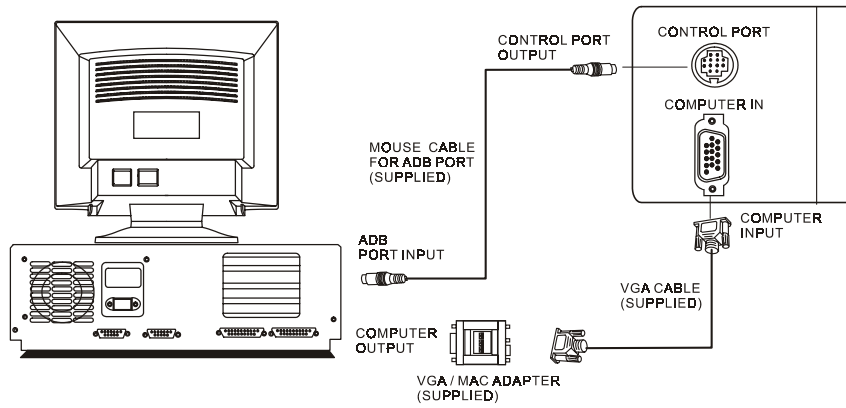

Figure 10 Connection to Macintosh

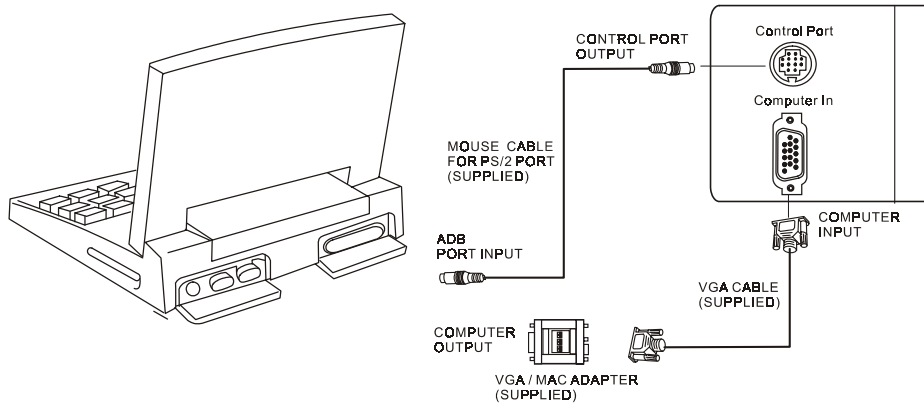

Figure 11 Connection to Power Book

Operation **3**

Turn On/Off Procedure

A. Power on

Press the **Standby/On** key to turn on the lamp. The **LED** will blink green during warm up and then light solid green.

- "INPUT SIGNAL DETECTED, ACTIVATING AUTO IMAGE" will be displayed on the screen after the projector has identified the input signal;
- "SEARCHING" message will be displayed on the screen if there is no signal input;
- "SYNC IS OUT OF RANGE" message will be displayed on the screen if the horizontal frequency of the input signal exceeds the range of the projector.

B. Standby

Press the **Standby/On** key, the following messages will be displayed to make sure you really want to power off the unit:

- Are you sure to power off?
- Press "Power" again to power off.

The **LED** will then blink orange and the lamp will shut down, but the fan will continue to run for about 1 minute to cool the lamp. After the fan stops, the **LED** will turn to a light solid orange.

***Lamp Protection Procedure:** If you try to turn on the lamp again while the **LED** is blinking, the projector will ignore the command until it cools down for one minute.

External Control

A. Control Pad

Hotkey

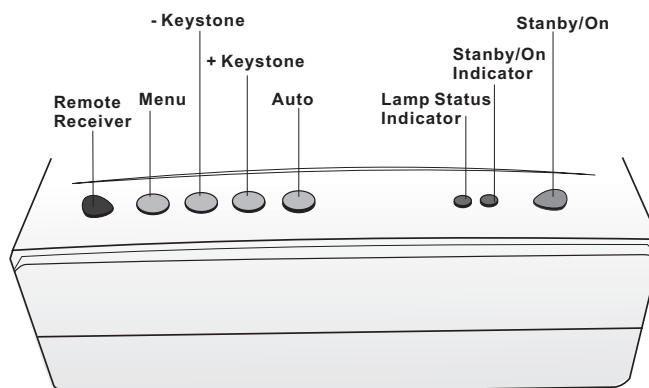

Figure 12 Hotkey control pad

MAIN UNIT	FUNCTION
AUTO	To correct the size and phase of the projected image automatically.
KEYSTONE +	To correct the upper distortion of the projected image when keystone occurs.
KEYSTONE -	To correct the lower distortion of the projected image when keystone occurs.
MENU	To call the OSD menu.
Standby/On	To turn the projection lamp on and off.
Standby/On indicator	Functions as an indicator showing the standby status.
Lamp status indicator	Lights or blinks when the lamp does not light.

Menu operation

When you press MENU button into OSD menu, all hot keys become manual operating buttons.

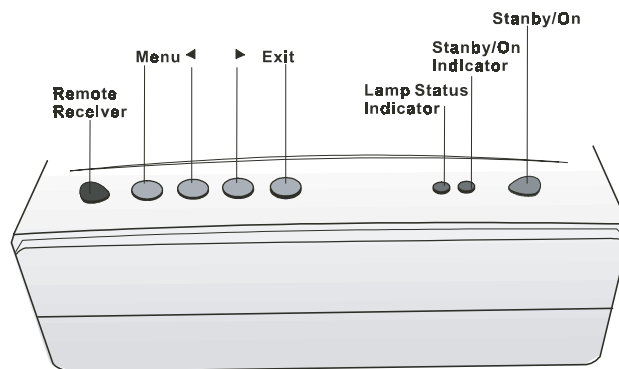

Figure 13 Menu control pad

MAIN UNIT	FUNCTION
Menu	To call the OSD menu. To enter sub pages. To select items.
▶ (KEYSTONE+)	To navigate through sub pages or to increase the scale bar number.
◀ (KEYSTONE-)	To navigate through sub pages or to decrease the scale bar number.
Exit (AUTO)	To exit from the current page or OSD menu, and save setting changes.

B. Remote Control

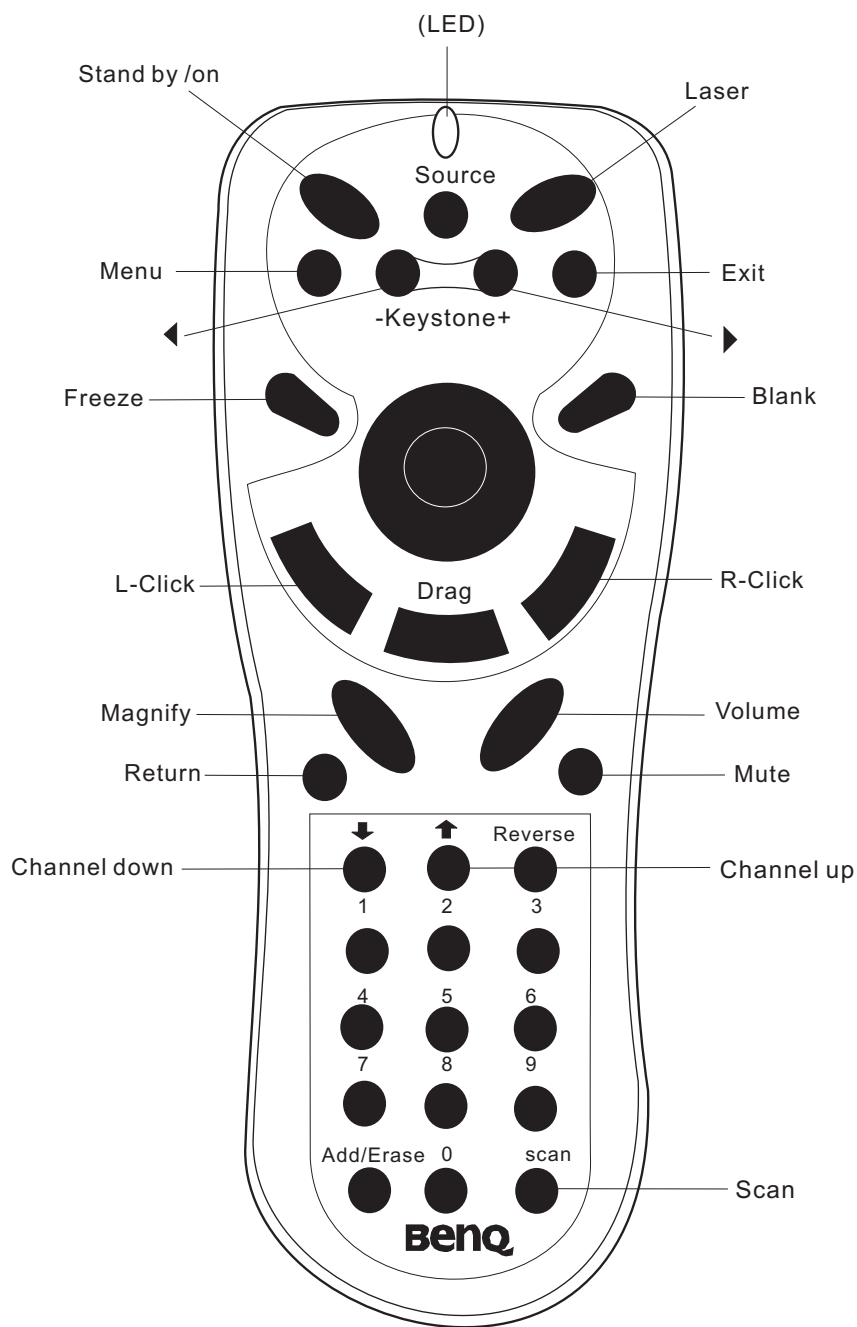

Figure 14 Remote control

Main Unit	Function
Standby/On	To turn the projection lamp on and off.
Freeze	Pressing this button displays a still (frozen) picture.
Magnify	Pressing this button partially magnifies a displayed picture. (Move the picture with the Disk Pad after pressing the Magnify button.)
Disk Pad	When the OSD menu is active, Disk Pad acts as ▲ ▼ selecting device. When the on-screen menus are not active, it works as mouse pad. When the magnify function is active, use disk pad to move through the picture.
Menu	Call the OSD Menu. To enter sub pages. To select items.
Blank	The blank screen is displayed by pressing Blank. And the blank screen will be revealed partially from top to bottom by pressing Blank again.
Source	Selects the input source.
Mute	Mutes the sound.
Volume	Adjusts volume. The sound gets louder or quieter by pressing the "+" or "-" button.
Laser	Laser pointer on button. Use as a stick (for indication).
Mouse Left-Click	When operating in mouse emulation mode, it registers a left mouse click.
Mouse Right- Click	When operating in mouse emulation mode, it registers a right mouse click.
Exit	To leave current OSD Pages.
◀ ▶ Drag	To move Left/Right among OSD items.

The remote control allows you to operate the function keys on the projector and to emulate mouse function when the projector is connected to a computer.

Inserting Batteries in the Remote Control

Be sure to follow instructions in placing batteries into the remote control units.

- Push and slide the lid in the direction of the arrow.
- Install two 'AAA' batteries as indicated inside the battery compartment.
- Replace the lid and snap into place.

⚠ Caution

- **Avoid excessive heat and humidity.**
- **Do not mix new and old or different types of batteries.**

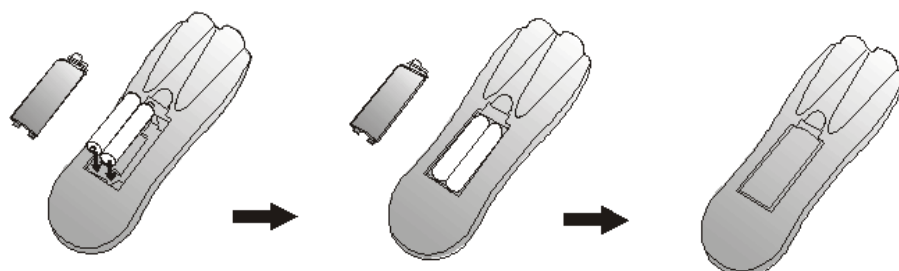

Figure 15 Battery replacement process

Remote Control Range

The remote sensors are located on the back of the unit. It can function in a range 50 degrees horizontal and 30 degrees vertical relative to a line that is a right angle to the remote sensor. The distance between the remote control and remote sensor must be shorter than four meters (13 feet).

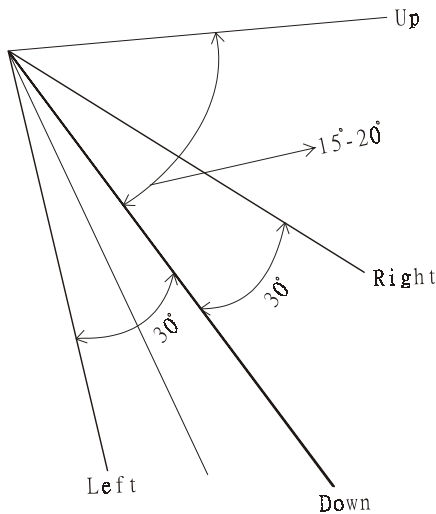

Figure 16 Range

Usage and Replacement of Lamp

The light source lamp has a limited service life.

The picture will become dark or the color will fade after the lamp has been used for a long time. In such cases, continued use of the lamp could cause a malfunction. Replace the lamp with a new one.

A. Lamp/temperature Status LED Indicator

I. Lamp in excess of service hours

When the LED light is a continuous red, it means the lamp has exceeded 1500 service hours. After this light appears, it is advisable to replace the projection lamp as soon as possible.

<p>PLEASE CHANGE A NEW LAMP AND RESET THE LAMP TIMER</p> <p>Figure 17 Lamp replacement warning signal I</p>	<p>“PLEASE CHANGE A NEW LAMP. AND RESET THE LAMP TIMER” will be displayed on the screen if the lamp has been operated for 1400 hours (see figure 17).</p>
<p>PLEASE CHANGE A NEW LAMP THE POWER WILL TURN OFF AFTER 20 HOURS</p> <p>Figure 18 Lamp replacement warning signal II</p>	<p>“PLEASE CHANGE A NEW LAMP. THE POWER WILL TURN OFF AFTER 20 HOURS” will be displayed on the screen if the lamp has been operated for 1480 hours. The “20” will count down (see figure 18).</p>
<p>PLEASE CHANGE A NEW LAMP</p> <p>Figure 19 Lamp replacement warning signal III</p>	<p>“PLEASE CHANGE A NEW LAMP” will blink on the screen together with a red LED if the lamp has been operated for more than 1500 hours (see figure 19). The warning message will display for 30 seconds every 5 minutes and after turn on 10 minutes, “Out OF LAMP USAGE TIME, POWER OFF AUTOMATICALLY IN 30 SECONDS” will be displayed on the screen 30 seconds and power off automatically. (All of the above messages will display for 30 seconds, but each message will be displayed whenever you turn on the lamp again.)</p>

2. Lamp is not well attached

If the LED blinks rapidly, it indicates that the lamp is not attached properly.

3. Temperature is too high

If the projector's internal temperature is too hot to operate safely, the LED will blink slowly for one minute and then the lamp will turn off automatically.

4. Normal status

If the LED light is off, it means the lamp and temperature inside the projector are normal.

Caution:

The lamp indicator will light up when the lamp becomes too hot. Turn off the power and let the projector cool for 45 minutes, then turn it on again. If the indicator is still shining, contact your dealer.

B. Replacing the Lamp

Replacing the lamp

When replacing the lamp, turn off the projector and unplug the AC cord. Wait 45 minutes so that the lamp can cool. High-pressure lamp when hit, may explode if improperly handled.

Caution:

- ***Dispose of used lamps in accordance with local authorities.***
- ***As the lamp is made of glass, do not apply shocks to it or scratch it.***
- ***Also, do not use an old lamp, as this could cause the lamp to explode.***
- ***If it seems that the lamp has exploded (for example, an explosive sound is heard), disconnect the power cord from the outlet and ask your dealer to replace the lamp. The lamp is covered by a front glass panel and an air-tight structure, but, in rare cases, the reflector and the inside of the projector may be damaged by scattered, broken pieces of glass, which could cause injury while being handled.***

- i. Turn the main power switch off and disconnect the power cord from the outlet.
- ii. Remove the lamp cover.
 - If hot, the lamp could cause burns. Wait for about 45 minutes until lamp has cooled down.
 - Loosen a screw and remove the cover.
- iii. Loosen the screw and pull the handle to remove the lamp.
 - If the screw is not loosened completely, you could hurt your fingers.
 - Do not insert your hand into the box after the lamp has been removed. (There are optical parts inside that, if touched, could result in color unevenness, etc.)
- iv. Replace the lamp with a new one and fix it using the same screw.
 - Firmly tighten the lamp screw. Loose screws could result in a poor connection, which could cause the unit to malfunction.
- v. Install the lamp cover and fix it using a screw.
 - To prevent burns, install the lamp cover and secure it using the screw.

- Do not turn on power with lamp cover removed.
- Whenever the lamp is replaced, reset the total operation time of the lamp. Do not reset if the lamp has not been replaced.
- Do not reset the timer without changing the lamp, as this can cause the lamp to break.

Lamp Replacement Procedure

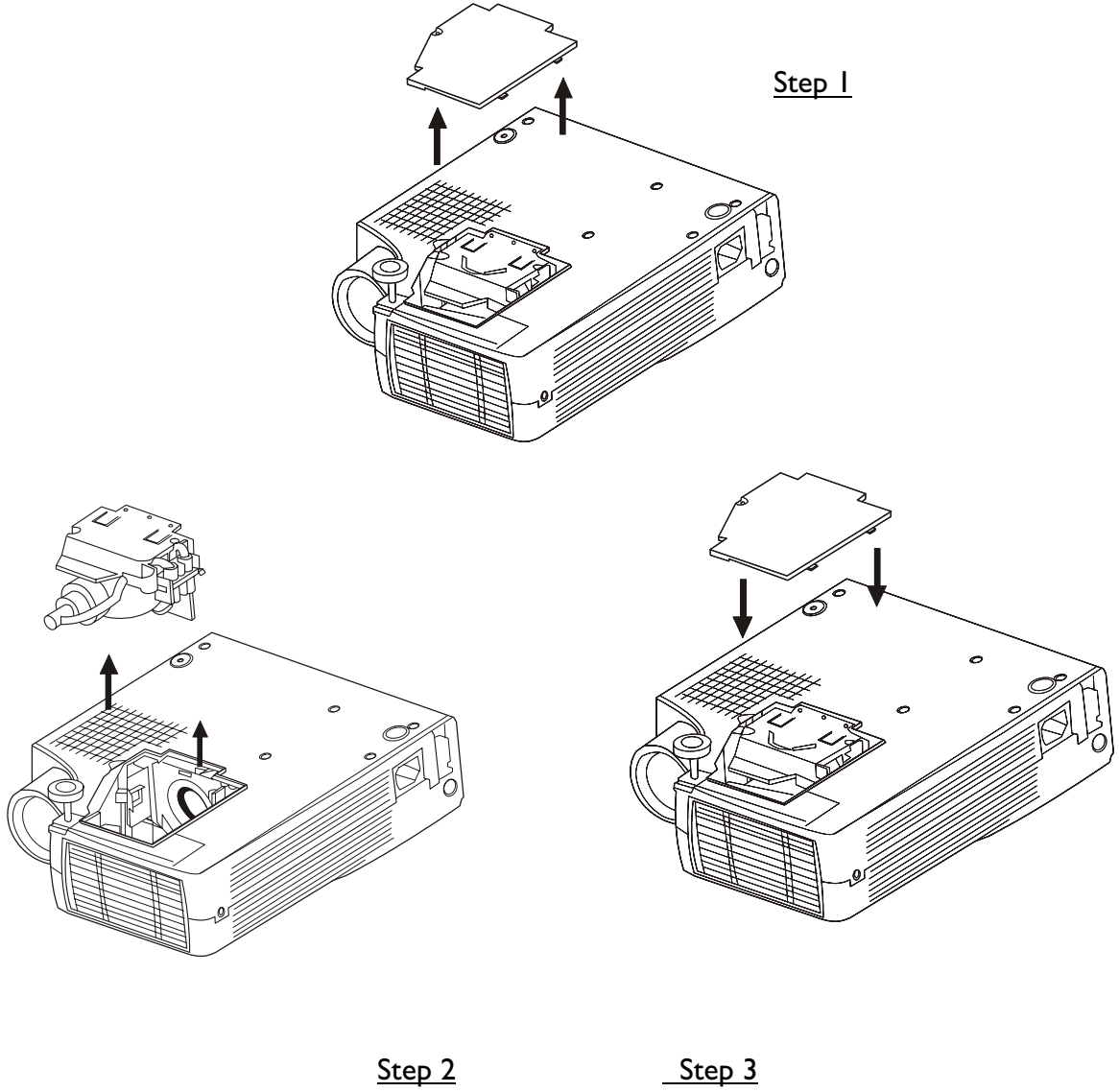





Figure 20 Lamp replacement: Step 1, Step 2, Step 3

Resetting Lamp Timer

If replacing the lamp after 1500 hours of operation, please carry out the following operation within 10 minutes of powering on.

OSD	FUNCTION
  	<p>Press the MENU button into OSD menu, and use “▶” (KEYSTONE+) or “◀” (KEYSTONE-) to select the Control page. Then press the Menu button again to highlight the Lamp item.</p> <p>Press “▶” (KEYSTONE+) or “◀” (KEYSTONE-) buttons, the lamp usage time will display on the bottom of the screen and can be adjusted.</p> <ul style="list-style-type: none"> • Use the “▶” (KEYSTONE+) or “◀” (KEYSTONE-) buttons to select the "Reset" item and press the “MENU” to reset the usage time. • After reset the usage time, press “EXIT” (AUTO) to save and exit.

OSD

Main OSD Menu

Press the “Menu” key and the main OSD menu structure will display as shown at right hand (Fig. 21). Whenever AV box is attached, 4 sub-pages will display in the menu: Display page, Image page, Control page, and Source page. However if input is from PC and no AV box is attached, Source page will not display in the menu.

Press the “Menu” key again to enter Display page items, or press “◀” (KEYSTONE-) or “▶” (KEYSTONE+) to select sub-pages. (The main OSD menu will automatically disappear if a key is not pressed within 10 seconds).

Press the “Exit” (AUTO) button to leave the current sub-page, and press “Exit” (AUTO) button again to leave the main OSD menu (at the same time the settings are saved).



Figure 21 Main OSD menu

Input status	PC input without AV box	PC input with AV box	Video input with AV box
Subpage	Display Image Control	Display Image Control Source	Display Image Control Source

A. Display Page

When a PC is the input source, there will be only four items on this page: Keystone, Brightness, Contrast, and Color Balance (Fig. 22). On the other hand, when the input source are video, S-video, TV or CATV, there will be other 4 items on this page: Keystone, Brightness, Contrast, and Sharpness (Fig.23).

Press the “Menu” button again to scroll through the items; press “◀” (KEYSTONE-) or “▶” (KEYSTONE+) to adjust the item scale, or press the “Exit” (AUTO) button to go back to the main OSD page.

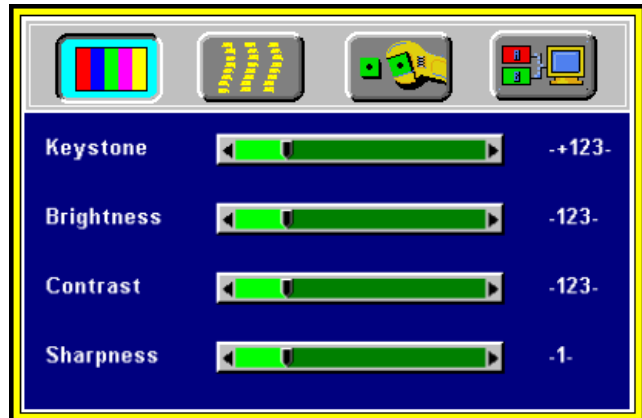

Figure 22 Display sub-page when the input source is PC (with/without AV box)

Figure 23 Display sub-page when the input source is video, s-video, TV or CATV

Setting effects			
Keystone	(Decrease)	←→	(Increase) Source is PC
Brightness	(Dark)	←→	(Bright)
Contrast	(Lower)	←→	(Higher)
Color Balance	(Red)	←→	(Blue)
Sharpness	(Soft)	←→	(Sharp) Source is Video

B. Image Page

Select the Image sub-page and the first item “Auto Resize” will be highlighted. There are five items on this page: Auto Resize, H. Phase, H. Size, H. Position, and V. Position (Fig. 24).

If AV box is attached and the input is from Video other instead of PC, another different Image sub-page including Image Ratio, System, Color and Tint will come out as Figure 25.

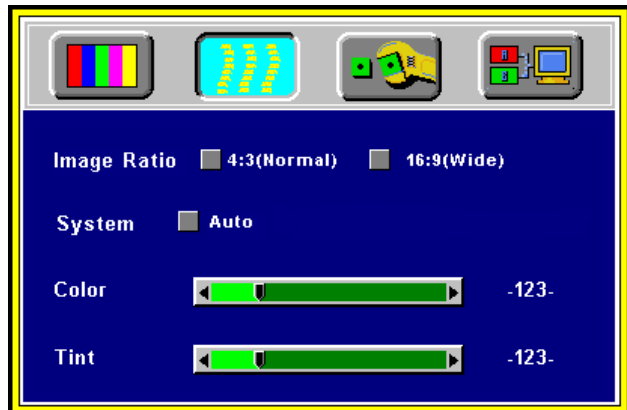
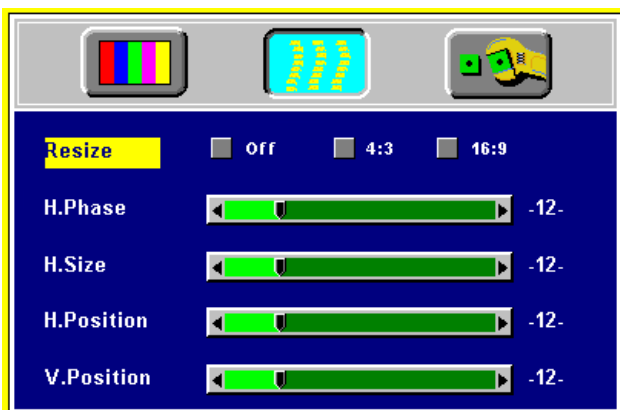

Figure 24 Image sub-page.... Only available when the input signal is PC

Figure 25 Image sub-page – Only available when the input signal is from video, S-video, TV or CATV



Setting effects	
Resize	When Resize is 4:3 or 16:9, the projector determines the best fit of the image to the screen.
H. Phase	If flicker occurs on a projected image, users may try to adjust the H. Phase manually.
H. Size	If the projected image is too wide or too narrow for the screen, users may turn Auto Image off and adjust the H. Size manually to fit the screen size.
H.Position	(move the image left)  (move the image right) The Auto Image should be turned off to activate the H. Position item. Position adjustments are saved when the projector is power off.
V. Position	(move the image down)  (move the image up) Position adjustments are saved when the projector is power off.

Image Ratio	4:3 (Normal)	16:9 (Wide)	
System	To select the input video system standard. When an AV box or turner box is attached, the projector will automatically detect the video system.		
Color	(Less) 	(More)	
Tint	(Red) 	(Green)	Source is Video or S-Video.

*Tint may not be adjusted with PAL/SECAM video signal input.

C. Control Page

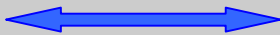
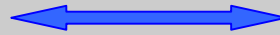
When users go into the Control sub-page, the first item “Auto” will be highlighted. There are five items on this page: Reset, Language, Mirror, Auto Off and Reset (Fig. 26).

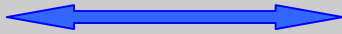

Figure 26 Control sub-page



Figure 27 Language selection

Setting effects	
Auto	To reset display, image and control settings to factory settings.
Language	To select the OSD menu language. Eight languages are supported: English, French, German, Italian, Spanish, Korean, Simplified Chinese and Traditional Chinese. (See Figure 27).
Mirror	To select Normal projection, H-Invert projection, V-Invert projection, or H/V Invert projection.
Auto Off	To set the time to turn the power off after the start up screen is displayed and no signal is detected or sync is out of range. To select, use “◀” (KEYSTONE-) or “▶” (KEYSTONE+) to set the time. 0 means Auto Off function inactive. *Default setting is 0 (stop).
Lamp	The usage time of lamp will display on this item. And you can reset the usage time of lamp from this item after you change a new lamp (See page 15).

D. Source Page

This Sub-page will only show up whenever AV box is attached.

There are five items on this page: Source, Volume, Treble, Bass, and Mute.

*The priority of input signal detection: (a.) PC (b.) S-Video (c.) Video.

*When selecting input sources, the projector will detect the selected input simultaneously, and the OSD menu will still exist on the screen.

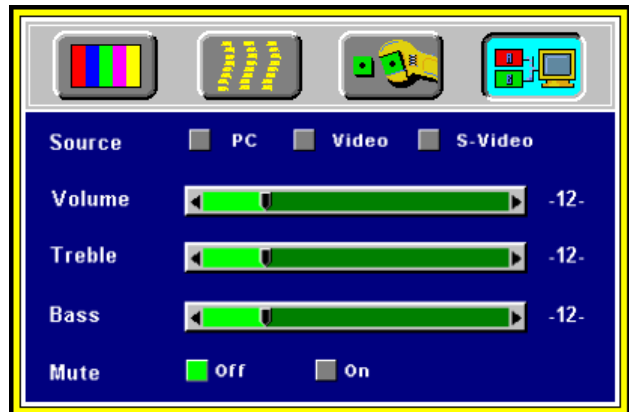
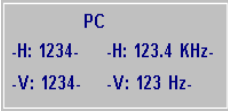





Figure 28 Source sub-page (AV box attached)

Items	Description
Source	3 input sources are available in the items when AV box is connected to the projector: PC, Video, S-video
Volume	To set the volume level of speaker built in the AV box.
Treble	To set the treble level of speaker built in the AV box.
Bass	To set the bass level of speaker built in the AV box.
Mute	To turn on/off the mute function.

Other Correspondent Remote Functions and Messages

OSD	FUNCTION
 <p data-bbox="339 477 448 510">Source</p>	<p data-bbox="695 353 1445 461">The selected source will be displayed at the bottom right of the screen for 3 seconds after selecting the source. (PC, VIDEO, S-VIDEO).</p>
 <p data-bbox="339 692 448 725">Freeze</p>	<p data-bbox="695 524 1445 790">The image will be frozen when the “Freeze” button is pressed. A “ ” mark appears at the lower right of the screen for 3 seconds during the freeze function. Furthermore, a “▶” mark appears at the lower right of the screen for 3 seconds when freeze is released. “Freeze” is released when the source button or the “Freeze” button is pressed again.</p>
 <p data-bbox="352 898 435 931">Mute</p>	<p data-bbox="695 801 1445 947">Press the “Mute” button and the sound will be muted. There will be an OSD message as shown below. Press Mute again or the volume +/- buttons to turn off the mute.</p>
 <p data-bbox="333 1061 454 1095">Volume</p>	<p data-bbox="695 963 1445 1108">Press volume + or – buttons to adjust the volume. The OSD message below will appear. (The message will disappear automatically 3 seconds after the volume is adjusted.)</p>
 <p data-bbox="333 1279 454 1312">Magnify</p>	<p data-bbox="695 1122 1445 1379">By pressing the magnify “+” button, the center of the picture can be magnified. Press the button again, and the image will be further magnified (to a maximum of 4X). Press the magnify “-” button, and the size of the magnified image will be reduced by 50 percent. To return to the normal display mode, press the “Return” button.</p>
<p data-bbox="352 1391 435 1424">Laser</p>	<p data-bbox="695 1391 1286 1424">Press this button to generate the laser beam.</p>
<p data-bbox="327 1570 461 1603">Disk Pad</p>	<p data-bbox="695 1442 1445 1733">If users connect the PS2 (ADB) mouse cable on the projector with the PC/Notebook (Macintosh/ Powerbook) mouse port, the disk pad will be able to function as a PC/Notebook (Macintosh/ Powerbook) mouse. When an image has been magnified, press the “Disk Pad” button to move around the display area (the mouse function is not available when magnify function is on).</p>
<p data-bbox="352 1767 435 1800">Drag</p>	<p data-bbox="695 1749 1445 1816">This button is a toggle switch to turn on/off the drag function of the remote mouse.</p>
<p data-bbox="349 1850 438 1883">Blank</p>	<p data-bbox="695 1834 1445 1901">Press this button to activate or release the blank function.</p>

Maintenance and Troubleshooting **4**

A. Lamp Replacement

Refer to Page 13.

B. Cleaning the Lens

Follow these steps to clean the projection lens:

1. Apply a non-abrasive camera lens cleaner to a soft, dry cleaning cloth (abrasive cleaners, solvents or other harsh chemicals might scratch the lens).
2. Avoid using an excessive amount of cleaner.
3. Lightly wipe the clean cloth over the lens.
4. Affix the lens cover whenever the projector is not in use.

C. Troubleshooting

PROBLEMS	TRY THESE SOLUTIONS
NO POWER	<ul style="list-style-type: none"> ✓ Plug the power cord into the AC Inlet. ✓ Plug the power cord into the power Inlet. ✓ Wait two minutes after the projector has been turned off before turning the projector back on.
NO PICTURE	<ul style="list-style-type: none"> ✓ Check that you have selected the proper input source. ✓ Ensure all cables are connected properly. ✓ Adjust the brightness and contrast. ✓ Remove the lens cap. ✓ Is the POWER indicator flashing? ✓ Is the STATUS Indicator flashing?
IMAGE ISN'T SQUARE ON THE SCREEN	<ul style="list-style-type: none"> ✓ Reposition the unit to improve its angle on the screen. ✓ Is the vertical offset properly corrected using the keystone function?
POOR COLOR	<ul style="list-style-type: none"> ✓ Select the correct video system. ✓ Adjust brightness, contrast, or saturation.
IMAGE IS BLURRED	<ul style="list-style-type: none"> ✓ Adjust the focus. ✓ Reposition the unit to improve its screen angle. ✓ Ensure the distance between the unit and screen is within the adjustment range of the lens.
REMOTE CONTROL DOESN'T WORK	<ul style="list-style-type: none"> ✓ Replace the batteries with new ones. ✓ Make sure there is no obstacle between the remote control and the unit. ✓ Stand within 4 meters (13 feet) of the unit. ✓ Make sure nothing is blocking the receiver on the control pad.
NO SOUND	<ul style="list-style-type: none"> ✓ Check audio cable connection from audio input source. ✓ Adjust audio source. ✓ Press "Volume" (+) button. ✓ Press "Mute" button.

Specifications

5

A. Optical

DMD™	1-chip 0.7" DMD™ (Digital Micromirror Device)
Lens	Manual zoom, manual focus (F/#= 2.8)
Lamp	mercury lamp 150W
Image size	23" to 300"
Projection Distance	1 to 10 M
Contrast Ratio	450:1

B. Electrical

Inputs	RGB (H:31.47 to 68.70 kHz V:56.25 to 85.00 Hz)
Video	(NTSC/PAL/SECAM/NTSC 4.43)
Color Reproduction	Full color, 16.7 million colors simultaneously.
Power Requirement	100 to 240 VAC, 50 to 60 Hz

C. Mechanical

Dimensions	24.3 cm (L) × 6.2 cm (H) × 19.8 cm (W)
Net Weight	2.3 kg/5.0 lb.
Operational Temperature projector	10°C to 40°C
Remote control	

D. Preset Display Resolution Table

Resolution	H Sync (kHz)	V Sync (Hz)	Remark
640x350	31.5	70.1	
640x400	37.9	85.1	VESA
720x400	31.5	70.0	
720x400	37.9	85.1	VESA
640x480	31.5	60.0	VESA
640x480	37.9	72.8	VESA
640x480	35	66.7	Macintosh
640x480	43.3	85.0	VESA
800x600	35.2	56.3	VESA
800x600	37.9	60.3	VESA
800x600	46.9	75.0	VESA
800x600	48.1	72.2	VESA
800x600	53.7	85.1	VESA
832x624	49.7	74.5	Macintosh
1024x768	48.4	60.0	VESA
1024x768	56.5	70.1	VESA
1024x768	60.0	75.0	VESA
1024x768	68.7	85.0	VESA
1280x1024	64.0	60.0	VESA

Appendix

Guideline to AV box

Features and Connection

AV Connection Port

This box is compatible with RCA input, S-Video input and audio output.

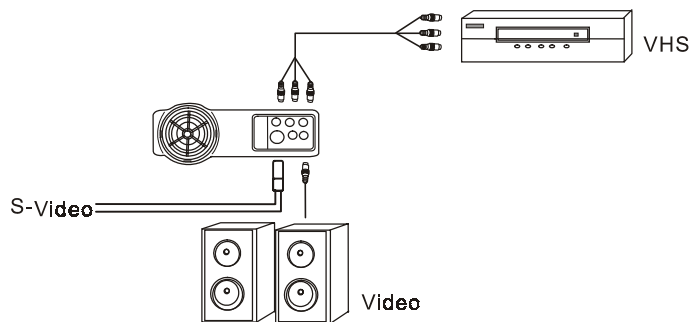

Figure 29 Connection of AV box

Speaker	
RCA Jack	For Video and Audio Input from VHS or V8
S Video Port	For S-Video Input

***AV box is sold separately and is not included in the standard configuration of accessories in the unit. Please contact the dealer if you need the box or visit our web site for more information.**

AV Control Pad

Source	Select the source
Volume up	Turn the volume upward
Volume down	Turn the volume downward

Connecting the Box

Please follow the instructions here to place the AV box:

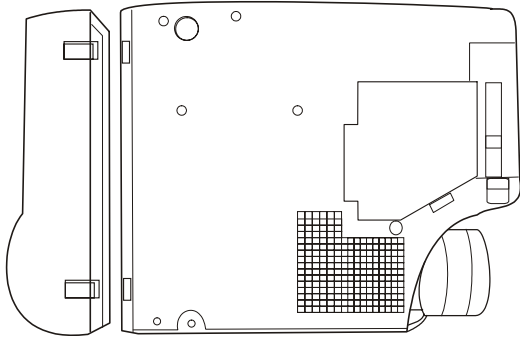

Figure 30 Bottom View of AV box

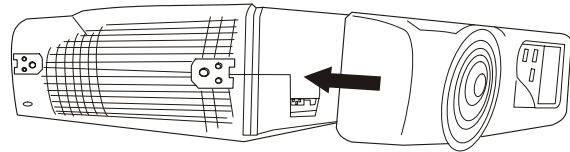

Figure 31 Side View of AV box

To attach the AV box to the unit :

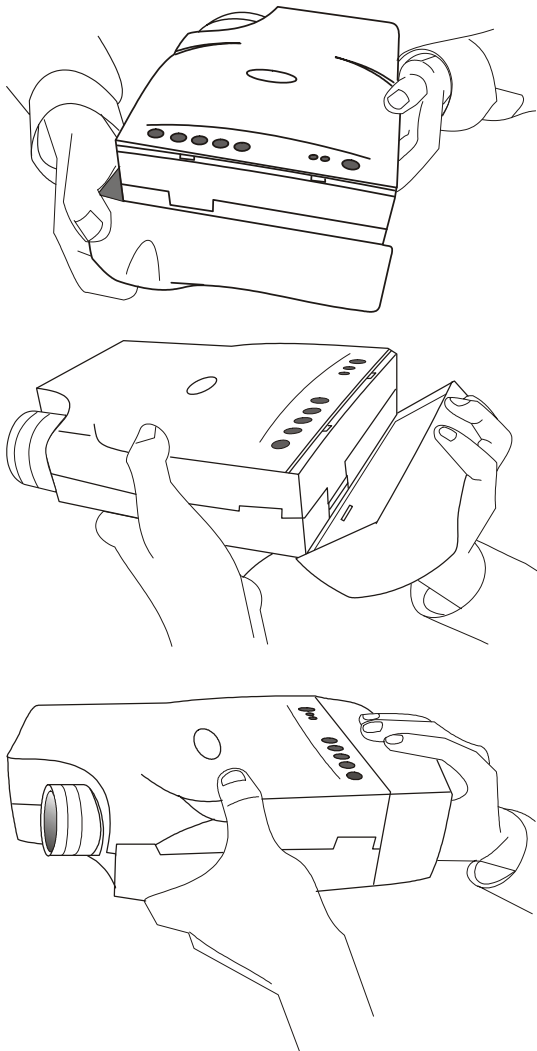

Figure 32 Connecting the Box

1. Precisely place the two chocks at the lower surface of the AV box into the lower slots in the correspondent position in the projector.
2. Slowly push the box to fit the unit and, meanwhile, insert the box plug into the A/V connector closely.
3. Plug in the correct cord into the correspondent jack or port to perform A/V function.
4. Select inputs by pressing "Source" key, and select channel by the channel up or down keys.